



Ingeniería Electrónica
SMART IDENT

MANUAL INSERTION TYPE

Specifications

User Manual

KYT-7400 Rev. J

Doc No	KYT74XX SERIES SPECIFICATIONS	REV	PAGE	DATE
		J	2 OF 45	2014. 03 .07.

KYT-74XX

Manual Insertion Type

RS-232C Interface & USB Interface Type

Magnetic Card Read &

IC Card Read / Write

3rd Floor, A-Dong,

Twin Town-Bldg, 703-2.

Gojan-Dong, AnSan-City,

Kyung Ki-Do, Korea (zip : 425-960)

Tel : 82 - 31 - 485 - 9480

Fax : 82 - 31 - 485 - 9488

E-mail : sales@kytronics.co.kr

<http://www.kytronics.co.kr>

Doc No	KYT74XX SERIES SPECIFICATIONS	REV	PAGE	DATE
		J	3 OF 45	2014. 03 .07.

● **REVISION HISTORY**

CHECK	DATE	DESCRIPTION	REV.	PAGE
1	2008.08.22	Revision-A Spec release	A	
2	2009.03.09	Card Locking function add	B	33
3	2009.04.20	USB interface add.	C	33
4	2009.07.29	Configuration table change	D	33
5	2011.03.08	Configuration table change	E	33
6	2011.06.22	Memory Card Command addition Software Reset Command addition F/W Download Mode Command addition	F	44
7	2011.08.26	Configuration table change	G	44
8	2012.02.06	Change the typo.	H	44
9	2013.12.08	Modified the wrong cmd (Lock cmd) from 'K'(4EH) to 'K'(4BH) and DIP SW Define	I	13, 14
10	2014.03.07	Modified the wrong cmd	J	44

Doc No	KYT74XX SERIES SPECIFICATIONS	REV	PAGE	DATE
		J	4 OF 45	2014. 03 .07.

C O N T E N T S

1. Overview	4
2. System Block Diagram	4
3. Configuration Table	5
4. Features	5
5. Environmental Requirements	5
6. Specifications	6
7. Interface Requirements	6
8. IC Card Process	8
9. RF Card Process	9
10. Technical Drawing	10
 Annex	
Interface	11

Doc No	KYT74XX SERIES SPECIFICATIONS	REV	PAGE	DATE
		J	5 OF 45	2014. 03 .07.

1. Overview

KYT- 74XX Series is a set of manual insertion type modules that provide for reading magnetic stripes confirming to ISO 7811. This model has a function that is a reading and writing a IC card confirming to ISO 7816-1,4 (T=0,T=1) card.

2. System Block Diagram

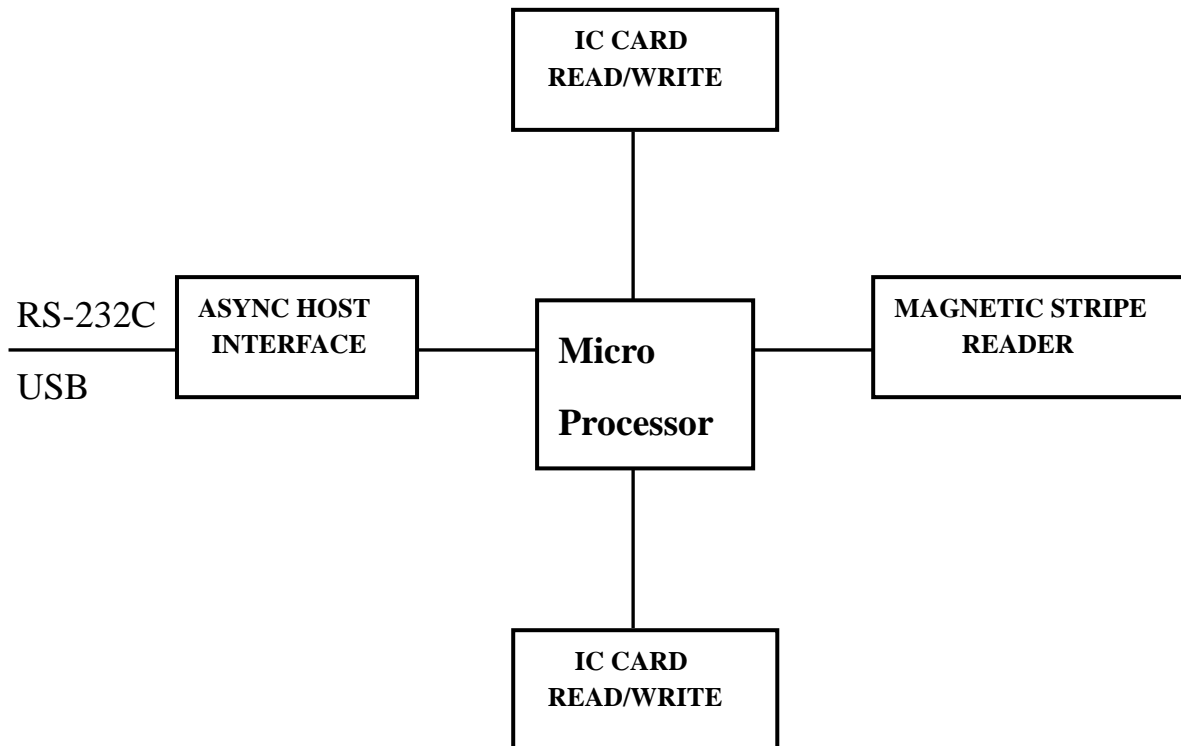

Doc No	KYT74XX SERIES SPECIFICATIONS	REV	PAGE	DATE
		J	6 OF 45	2014. 03 .07.

3. Configuration Table

KY - 7 4

INTERFACE	FUNCTION	Body	TRACK	OPTION I	Lock+Bezel Color	OPTION II	OPTION III
T : RS-232C L : TTL U : USB	7: MANUAL INSERTION MS/IC CARD READER	0 : - 4 : Flush Bezel	0: Without Magnetic 1: ISO 1 TRK 2: ISO 2 TRK 3: ISO 3 TRK 4: ISO 1,2 TRK 5: ISO 1,3 TRK 6: ISO 2,3 TRK 7: ISO 1,2,3 TRK	0: Without IC 1: With IC 2: With SHUTTER 3: IC+SHUTTER 4: IC + SAW 5: IC + SAW + SHUTTER 6: IC+SAW (2 Slot) 7: IC+SAW (4 Slot) 8: IC+SHUTTER+SAW(2 Slot) 9: IC+SHUTTER+SAW(4 Slot)	0: Without LOCK + Silver Color 1: MOTOR LOCK + Silver Color 2: Without LOCK + Black Color 3: MOTOR LOCK + Black Color	0: Without RTS & CTS 1: With RTS & CTS R: Without RS232C	0:- P-RF CARD

4. Features

- 4.1 Magnetic Stripe reading Triple tracks.
- 4.2 Flush type metal Bezel.
- 4.3 RS-232C interface with a HOST.
- 4.4 IC Card read and writes.
- 4.5 The IC contact is designed to minimize scratch on the IC card.
- 4.6 Mag. Head and Chip contacts are located on the opposite side.
- 4.7 Support T=0 and T=1 protocol.
- 4.8 Supports ISO14443 Mifare® Card.
- 4.9 When Power failure, card locking is released automatic.

5. Environmental Requirements

- 5.1 Operating Temperature and Humidity: 0~55°C, 0~95% RH
- 5.2 Conservation Temperature and Humidity: -20~70°C, 0~95% RH
- 5.3 Vibration: Amplitude 2mm, 10~40 Hz in x, y, z direction

6. Specifications

- 6.1 Card Standard: ISO 7811, ISO 7816
- 6.2 Mag. Track No: I(IATA), II(ABA), III(MINTS)
- 6.3 Mag. Reading Method: F2F (FM)
- 6.4 Mag. Reading Density: 210 BPI(I, III), 75 BPI(II)
- 6.5 Mag. Reading Capacity: I(IATA) – 79 Characters.
: II(ABA) – 40 Characters
: III(MINTS) – 107 Characters.
- 6.6 Card Thickness: 0.76 ±0.08 mm
- 6.7 Power Consumption
 - 6.7.1 Input voltage: DC +5V ±5%
 - 6.7.2 Ripple: Less than 50 mV p-p
 - 6.7.3 Operating: Less than 1A

Doc No	KYT74XX SERIES SPECIFICATIONS	REV	PAGE	DATE
		J	7 OF 45	2014. 03 .07.

6.8 IC Contact Resistance: Less than 0.5Ω

6.9 IC Contact Force: 0.2N ~ 0.6N

6.10 Operation Locus: Indoors Only

6.11 Magnetic Card Feeding Speed: 15~70 cm/sec

6.12 Life – Cycles.

: HEAD – Min. 500,000 Cycles(1Cycle = 2Pass)

: IC CARD CONTACT – Min. 500,000 Cycles

6.13 Weight: Including METAL BEZEL – 169g

Weight can change According to the Customer Version.

6.14 Banding Card – Long side: Less than 3mm

6.15 Banding Card – Short side: Less than 2mm

7. Interface Requirements.

7.1 Standard.

7.1.1 RS-232C Interface.

Part Number: D-SUB Standard 9Pin

Part Number: 53015-0710(Molex)

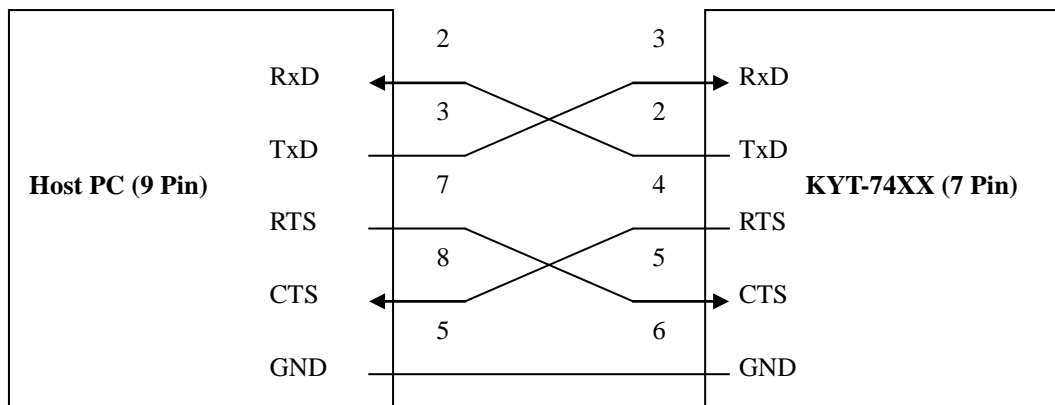

- Transmission Distance: Max. 1.5m

7.1.2 Pin Assignment.

* Connector Location Number: J4 - Part Number: 53015-0710(Molex)

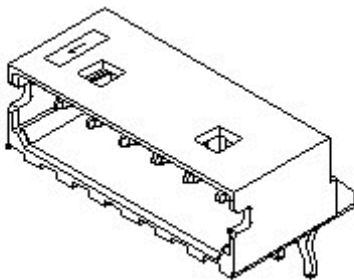

PIN N0	NAME
1	VCC
2	TXD
3	RXD
4	RTS
5	CTS
6	GND
7	GND

Doc No	KYT74XX SERIES SPECIFICATIONS	REV	PAGE	DATE
		J	8 OF 45	2014. 03 .07.

7.2 USB Interface.

* Mini USB : B TYPE CONNECTOR 5PIN

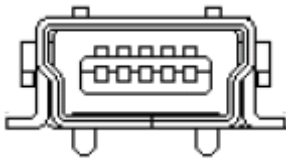

- Mini USB B & C TYPE CABLE (5PIN)



Doc No	KYT74XX SERIES SPECIFICATIONS	REV	PAGE	DATE
		J	9 OF 45	2014. 03 .07.

8. IC Card Process

KYT-74XX accepts most of IC cards supporting ISO 7816 T=0 and T=1.

◆ Number and Location of the contacts on IC Card

: Number and location of the contacts on IC Card is specified in ISO 7816-2 figure 2 Refer to Appendix A.

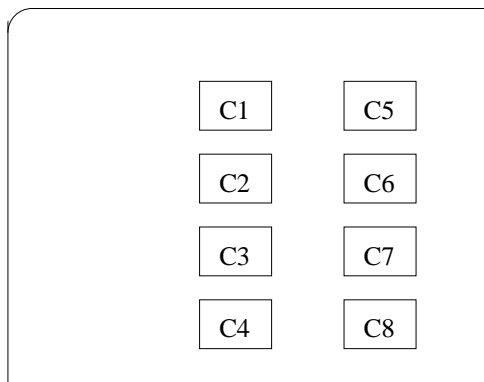

- C1: VCC (Supply voltage)
- C2: RST (Reset signal)
- C3: CLK (Clock signal)
- C4: Reserved to ISO/IEC JTC 1/SC 17 for future use.
- C5: GND (Ground)
- C6: VPP (Programming voltage)
- C7: I/O (Data input/output)
- C8: Reserved to ISO/IEC JTC 1/SC 17 for future use.

◆ Power Consumption

: Less than 50mA

9. RF Card Process

The KYT-74XX series is a compact read/write dummy terminal and supports ISO 14443 Mifare® Contactless Smart Cards.

All the process of KYR-74XX consists of Execution and Response according to the Commands from Host. And the Response includes Execution Results.

◆ Power Consumption

: Less than 40mA

Doc No	KYT74XX SERIES SPECIFICATIONS	REV	PAGE	DATE
		J	10 OF 45	2014. 03 .07.

11. Technical Drawing

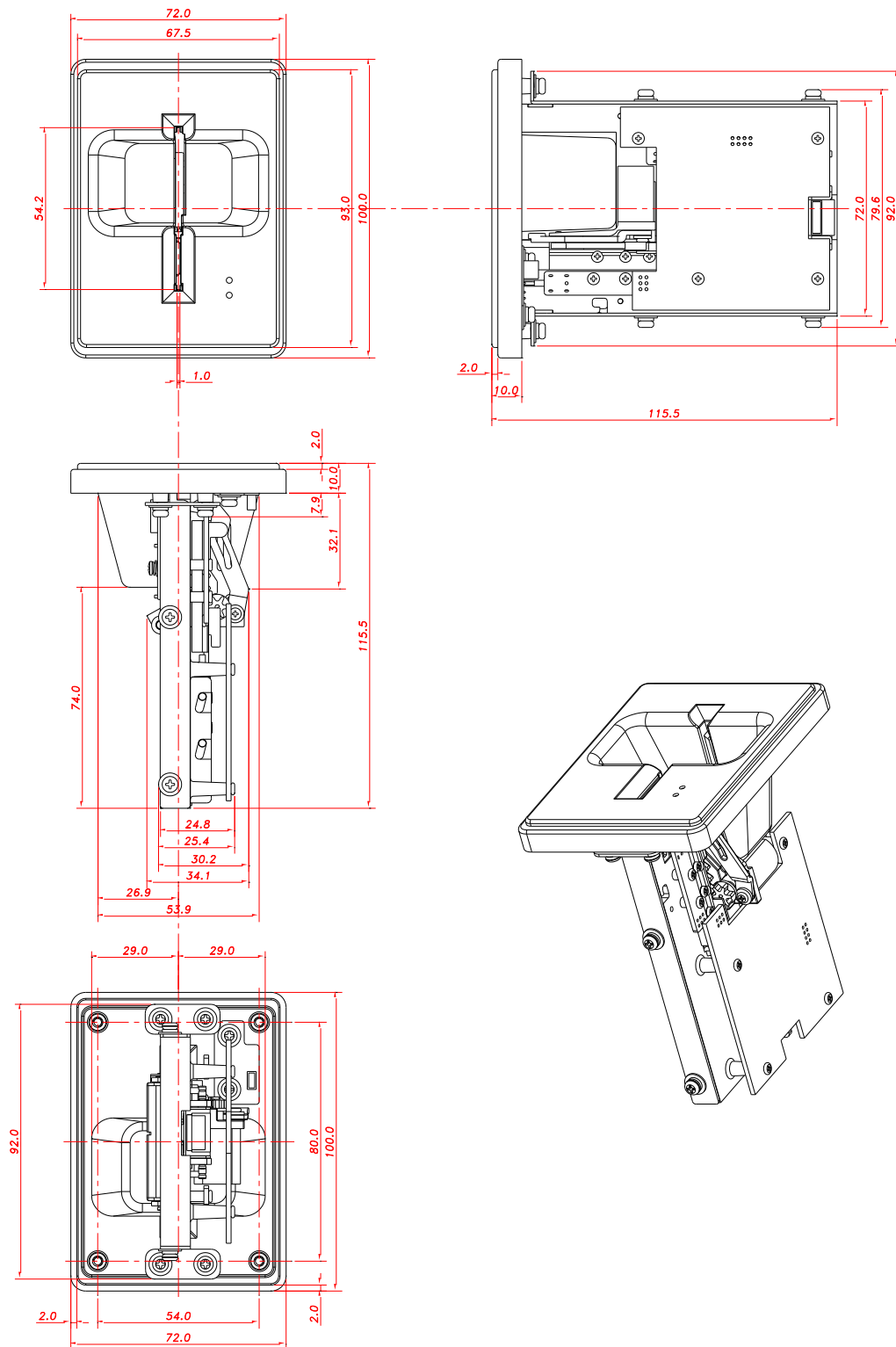

*** Dimensions are subject to be changed according to the customer requirements.**

Doc No	KYT74XX SERIES SPECIFICATIONS	REV	PAGE	DATE
		J	11 OF 45	2014. 03 .07.

Interface

MS Reader & IC & RF Card Reader/Writer

MODEL: KYX- 74XX Series

Doc No	KYT74XX SERIES SPECIFICATIONS	REV	PAGE	DATE
		J	12 OF 45	2014. 03 .07.

1. Communication Method.

- 1.1. Asynchronous, Half duplex.
- 1.2. Baud Rate: 9600, 19200 38400 (Default: 19200 BPS)
- 1.3. Start Bit: 1Bit
- 1.4. Data Length: 8Bits
- 1.5. Parity: None
- 1.6. Stop Bit: 1Bit

2. Control Characters.

NANE	Hex Value	Description
SOH	01	Start of Header
STX	02	Start of Text
ETX	03	End of Text
EOT	04	End of Transmission
ENQ	05	Enquiry
ACK	06	Positive Acknowledge
NAK	15	Negative Acknowledge
CAN	18	Cancel

3. Frame Format.

3.1. Command structure

STX	Len_H	Len_L	CMD	DATA	ETX	BCC
-----	-------	-------	-----	------	-----	-----

Ref) Command Sets List

3.2. Response structure

3.2.1. Positive Packet structure

STX	Len_H	Len_L	'P'	STAT	DATA	ETX	BCC
-----	-------	-------	-----	------	------	-----	-----

3.2.2. Negative Packet structure

STX	Len_H	Len_L	'N'	ST1	ST2	ETX	BCC
-----	-------	-------	-----	-----	-----	-----	-----

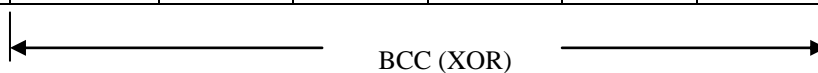

Ref.) Negative Response Code (ST1, ST2) List

3.3. Data Length range of Len_H and Len_L.

- 3.3.1 Command structure: Data Length from CMD to DATA.
- 3.3.2 Positive Packet structure: Data Length form 'P' to Data.
- 3.3.3 Negative Packet structure: Data Length form 'N' to ST2.

Doc No	KYT74XX SERIES SPECIFICATIONS	REV	PAGE	DATE
		J	13 OF 45	2014. 03 .07.

3.4. STAT Structure Format

BIT 7	BIT 6	BIT 5	BIT 4	BIT 3	BIT 2	BIT 1	BIT 0
-------	-------	-------	-------	-------	-------	-------	-------

BIT	Description		REMARK
	1	0	
7	Rear Detect ON	None Detect at Rear Sensor	
6	Front Detect ON	None Detect at Front Sensor	
5	IC Reset ON	No ICC Reset	If Card is got out of Rear Sensor area by artificial means, terminal is deactivated.
4	Is M/S Data	None M/S Data	
3	M/S Forward Read ON	M/S Backward Read ON	
2	Card Locking On	Card Locking OFF	With motor
1	Is SAM2	None SAM2	(Option)
0	Is SAM1	None SAM1	

4. Communication Protocol Sequence.

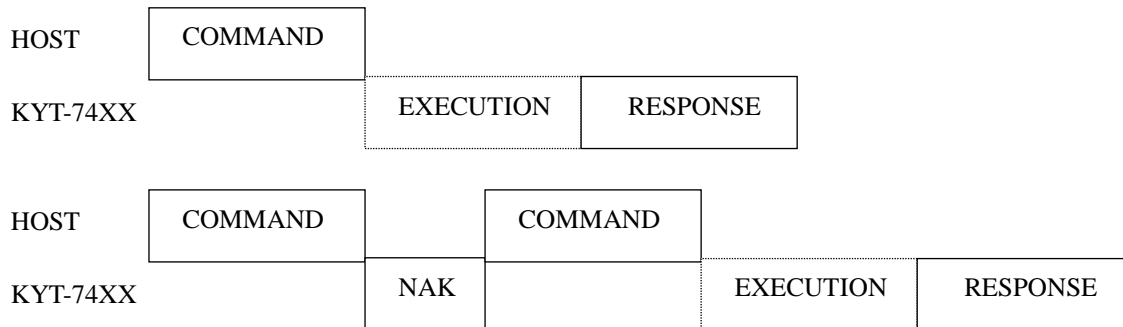

Cf.) The point of the time when SLAVE transmit “NAK”.

1. When BCC is incorrect. (BCC: Last byte of Each COMMAND).
2. When SLAVE can't receive each byte of COMMAND within 20ms.

DIP S/W Setting.

PIN	STATUS	Mark
1,2	OFF OFF	RS232C & RTSCTS
	ON OFF	RS232C
	OFF ON	RS232C
	ON ON	USB
3	ON	RF
4	ON	H/W Motor control(Fixed)
5	OFF	MS Card
6	OFF	IC Card
7	OFF	Fixed
8	ON	SEL(memory) Card.

Doc No	KYT74XX SERIES SPECIFICATIONS	REV	PAGE	DATE
		J	14 OF 45	2014. 03 .07.

5. Command Sets List.

Index	CMD	Description	Note
Request	'S'(53H)	Status Request	
	'V'(56H)	Read F/W Version of unit	
IC Card Control	'R'(52H)	ICC Reset	ICC Control Command
	'P'(50H)	PTSS(PPSS) Application	
	'I'(49H)	ICC Direct Control	
	'D'(44H)	ICC Deactivation.	
RF Card	'F'(46H)	RF Card Control	Cf.) Page 22
Setting	'B'(42H)	Baud rate change	
	'W'(57H)	Software Reset	
	'Q'(51H)	F/W Download Mode	
Select	'L'(4CH)	IC Card Select	
MS Read	'M'(4DH)	Magnetic data read command	
	'C'(43H)	Magnetic data clear command	
Eject	'E'(45H)	Card Eject	
Lock	'K'(4BH)	Card Lock	
Memory Card	'Z'(5AH)	Memory Card(SLE4428,SLE4442) Command	

Doc No	KYT74XX SERIES SPECIFICATIONS	REV	PAGE	DATE
		J	15 OF 45	2014. 03 .07.

6. Negative Response Code List.

NO	ST1	ST2	Description	NOTE	
1	'0'	'1'	Command Not Define		
2	'0'	'2'	No Card		
3	'0'	'3'	Card Fail		
4	'0'	'4'	Card Jam		
5	'0'	'5'	Data Fail		
6	'0'	'6'	Time Out		
7	'0'	'8'	M/S Blank Error	Magnetic Data Interpreter Error	
8	'0'	'9'	M/S Preamble Error		
9	'1'	'0'	M/S Parity Error		
10	'1'	'1'	M/S Post amble Error		
11	'1'	'2'	M/S LRC Error		
12	'1'	'4'	IC Card Contact Error	IC Card	
13	'1'	'5'	IC Card Control Error		
14	'1'	'6'	Command Cancel		
15	'1'	'8'	EEPROM Error	RF Card	
16	'2'	'0'	Not Detected at the Antenna.		
17	'2'	'1'	MIFARE Card Error (On Authentication)		
18	'2'	'2'	MIFARE Card Error (Not Selected RF Card)		
19	'2'	'3'	MIFARE Card Read Error		
20	'2'	'4'	MIFARE Card Write Error.		
21	'2'	'5'	MIFARE Card Increment(Decrement) Error		
22	'2'	'6'	Read Data Format Error(Character - Error)		
23	'2'	'7'	RF Initial Error		
25	'2'	'8'	The Carrier wave not emitted in antenna		
24	'2'	'9'	RF Card Contact Error		
30	'3'	'0'	Block Error		
31	'4'	'0'	SLE4442 PSC Modify Error.		Memory card
32	'4'	'1'	SLE4442 PSC Read Error		
33	'4'	'2'	SLE4442 Memory Read Error		
34	'4'	'4'	SLE Card Control Error		
35	'4'	'5'	SLE Card Contact Error		
36	'4'	'6'	SLE4428 PSC Modify Error.		
37	'4'	'7'	SLE4428 PSC Read Error		
38	'4'	'8'	SLE4428 Memory Read Error		

Doc No	KYT74XX SERIES SPECIFICATIONS	REV	PAGE	DATE
		J	16 OF 45	2014. 03 .07.

7. Command Detail.

7.1 Request

7.1.1 'S' (53H): Status Request.

Command Packet

STX	00H	01H	'S'	ETX	BCC
-----	-----	-----	-----	-----	-----

Positive Response Packet

STX	Len_H	Len_L	'P'	STAT	ETX	BCC
-----	-------	-------	-----	------	-----	-----

Negative Response Packet

STX	Len_H	Len_L	'N'	ST1	ST2	ETX	BCC
-----	-------	-------	-----	-----	-----	-----	-----

7.1.2 'V' (56H): F/W Version Read.

Command Packet

STX	00H	01H	'V'	ETX	BCC
-----	-----	-----	-----	-----	-----

Positive Response Packet

STX	Len_H	Len_L	'P'	STAT	DATA	ETX	BCC
-----	-------	-------	-----	------	------	-----	-----

DATA Structure

'V'	X1	'.'	X2
-----	----	-----	----

Ex) "V1.00"

Negative Response Packet

STX	Len_H	Len_L	'N'	ST1	ST2	ETX	BCC
-----	-------	-------	-----	-----	-----	-----	-----

7.2 IC Card Control

7.2.1 'R' (52H): Command for sending Reset Signal Contacted IC Card and for receiving ATR from IC Card.

Command Packet

STX	00H	01H	'R'	ETX	BCC
-----	-----	-----	-----	-----	-----

Positive Response Packet

STX	Len_H	Len_L	'P'	STAT	DATA	ETX	BCC
-----	-------	-------	-----	------	------	-----	-----

DATA of above Positive Response Packet is a string of characters as many as a designated number of Byte read from a designated address in Command Packet.

The DATA Format is as below.

ICC ATR
(Length - 2) Byte

EX)

3B	6B	00	00	80	31	90	63	53	46	01	83	03	90	00
----	----	----	----	----	----	----	----	----	----	----	----	----	----	----

Negative Response Packet

STX	Len_H	Len_L	'N'	ST1	ST2	ETX	BCC
-----	-------	-------	-----	-----	-----	-----	-----

Doc No	KYT74XX SERIES SPECIFICATIONS	REV	PAGE	DATE
		J	17 OF 45	2014. 03 .07.

7.2.2 'P'(50H) : PTSS(PPSS) Application.

: ISO 7816 Standard prescribe that PTSS can execute only once directly after 'R' Command execution. And "Set Clock Rate Factor Register" Command can execute every time needed. But This Command set up communication speed of IFM, And so baud rate must be set up before this command execute

Command Packet

STX	Len_H	Len_L	'P'	TA1	ETX	BCC
-----	-------	-------	-----	-----	-----	-----

TA1 (1BYTE)								REMARK
7	6	5	4	3	2	1	0	
0	1			1 ~ 3				PTSS operating between Terminal and ICC according to ISO7816.
1	1			1 ~ 3				Set Clock Rate Factor Register (ICC interface Device – Chip)

<Low Nibble of 2'st Byte>

BIT6 ~ BIT 0	Decryption
0x11	9600bps
0x12	19200bps
0x13	38400bps

Positive Response Packet

STX	Len_H	Len_L	'P'	STAT	ETX	BCC
-----	-------	-------	-----	------	-----	-----

Negative Response Packet

STX	Len_H	Len_L	'N'	ST1	ST2	ETX	BCC
-----	-------	-------	-----	-----	-----	-----	-----

< PTSS operation method >

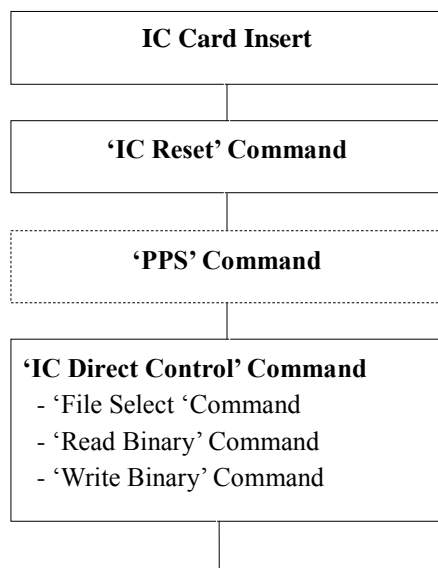

Can use 'PPS' command in case of IC card support to PTS

Doc No	KYT74XX SERIES SPECIFICATIONS	REV	PAGE	DATE
		J	18 OF 45	2014. 03 .07.

7.2.3 'I' (49H): ICC Direct Control

This is a command for operation under ISO 7816. Accordingly, user can handle all IC cards Conforming to ISO 7816 – 4 and T = 0, T= 1.

Command Packet

STX	Len_H	Len_L	'I'	DATA	ETX	BCC
-----	-------	-------	-----	------	-----	-----

Positive Response Packet

STX	Len_H	Len_L	'P'	STAT	DATA	ETX	BCC
-----	-------	-------	-----	------	------	-----	-----

Negative Response Packet

STX	Len_H	Len_L	'N'	ST1	ST2	ETX	BCC
-----	-------	-------	-----	-----	-----	-----	-----

- Note: Add to Data block of above Command Packet Command Packet specified in ISO 7816-4 APDU

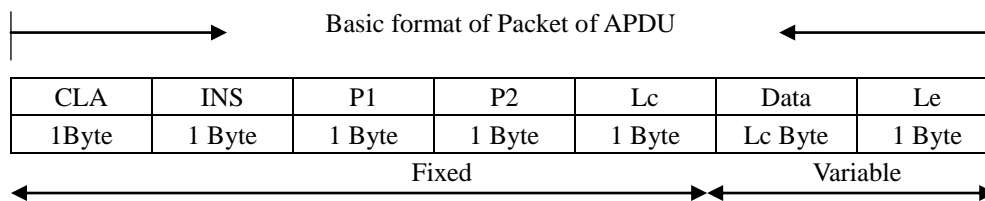

CLA	Class of instruction	Fixed
INS	Instruction code	
P1	Instruction parameter 1.	
P2	Instruction parameter 2	
Lc	Number of byte present in command data field	Variable
Data	String of data bytes sent in command (= Lc)	
Le	Maximum number of data byte expected in data field of response	

P.S) Lc is 0 if there is no "Data".

Command	INS Code (Hex Value)
Read Binary Command	B0
Write Binary Command	D0
Update Binary Command	D6
Erase Binary Command	0E
Read Record(s) Command	B2
Write Record Command	D2
Append Record Command	E2
Update Record Command	DC
Get Data Command	CA
Put Data Command	DA
Select File Command	A4
Verify Command	20
Internal Authenticate Command	88
External Authenticate Command	82
Get Challenge Command	84
Manage Channel Command	70

For more details, refer to IS 7816-4.

Doc No	KYT74XX SERIES SPECIFICATIONS	REV	PAGE	DATE
		J	19 OF 45	2014. 03 .07.

7.2.4 'D' (44H) : ICC Deactivation.

Command Packet

STX	00H	01H	'D'	ETX	BCC
-----	-----	-----	-----	-----	-----

Positive Response Packet

STX	Len_H	Len_L	'P'	STAT	DATA	ETX	BCC
-----	-------	-------	-----	------	------	-----	-----

Negative Response Packet

STX	Len_H	Len_L	'N'	ST1	ST2	ETX	BCC
-----	-------	-------	-----	-----	-----	-----	-----

7.2.5 'W' (57H) : Software Reset Command

Command Packet

STX	00H	01H	'W'	ETX	BCC
-----	-----	-----	-----	-----	-----

Positive Response Packet

STX	Len_H	Len_L	'P'	STAT	DATA	ETX	BCC
-----	-------	-------	-----	------	------	-----	-----

The following order after Response receiving transmits in 1.5Sec after and it becomes.

The terminal initially operating time is necessary

7.2.6 'Q' (51H): F/W Download Change Mode.

Command Packet

STX	00H	01H	'Q'	ETX	BCC
-----	-----	-----	-----	-----	-----

Positive Response Packet

STX	Len_H	Len_L	'P'	STAT	DATA	ETX	BCC
-----	-------	-------	-----	------	------	-----	-----

7.3 Setting

7.3.1 'B' (42H): Baud Rate Setting

Set up the baud rate of the Terminal (After then, you must set up baud rate of the host to the same value of the terminal)

Command Packet

STX	00H	02H	'B'	DATA	ETX	BCC
-----	-----	-----	-----	------	-----	-----

DATA:

- '0' – 9600 BPS
- '1' – 19200 BPS (Default)
- '2' – 38400 BPS

Positive Response Packet

STX	00H	02H	'P'	STAT	ETX	BCC
-----	-----	-----	-----	------	-----	-----

Negative Response Packet

STX	Len_H	Len_L	'N'	ST1	ST2	ETX	BCC
-----	-------	-------	-----	-----	-----	-----	-----

7.3.2 'L' (4CH): IC Card Select Command.(Option)

It's Default to Select IC Card when Power on.

When Received command of 'I' Card Reader controls card

To control SIM Card in SAM Slot, user should perform command of 'I' after this command is conducted.

Doc No	KYT74XX SERIES SPECIFICATIONS	REV	PAGE	DATE
		J	20 OF 45	2014. 03 .07.

Command Packet

STX	00H	02H	'L'	DATA	ETX	BCC
-----	-----	-----	-----	------	-----	-----

Data: '0' Selection of Inserted Card.

'1' Selection of SAM1 Slot

'2' Selection of SAM2 Slot

Positive Response Packet

STX	Len_H	Len_L	'P'	STAT	ETX	BCC
-----	-------	-------	-----	------	-----	-----

Negative Response Packet

STX	Len_H	Len_L	'N'	ST1	ST2	ETX	BCC
-----	-------	-------	-----	-----	-----	-----	-----

IC Card Processing Flow (Example)

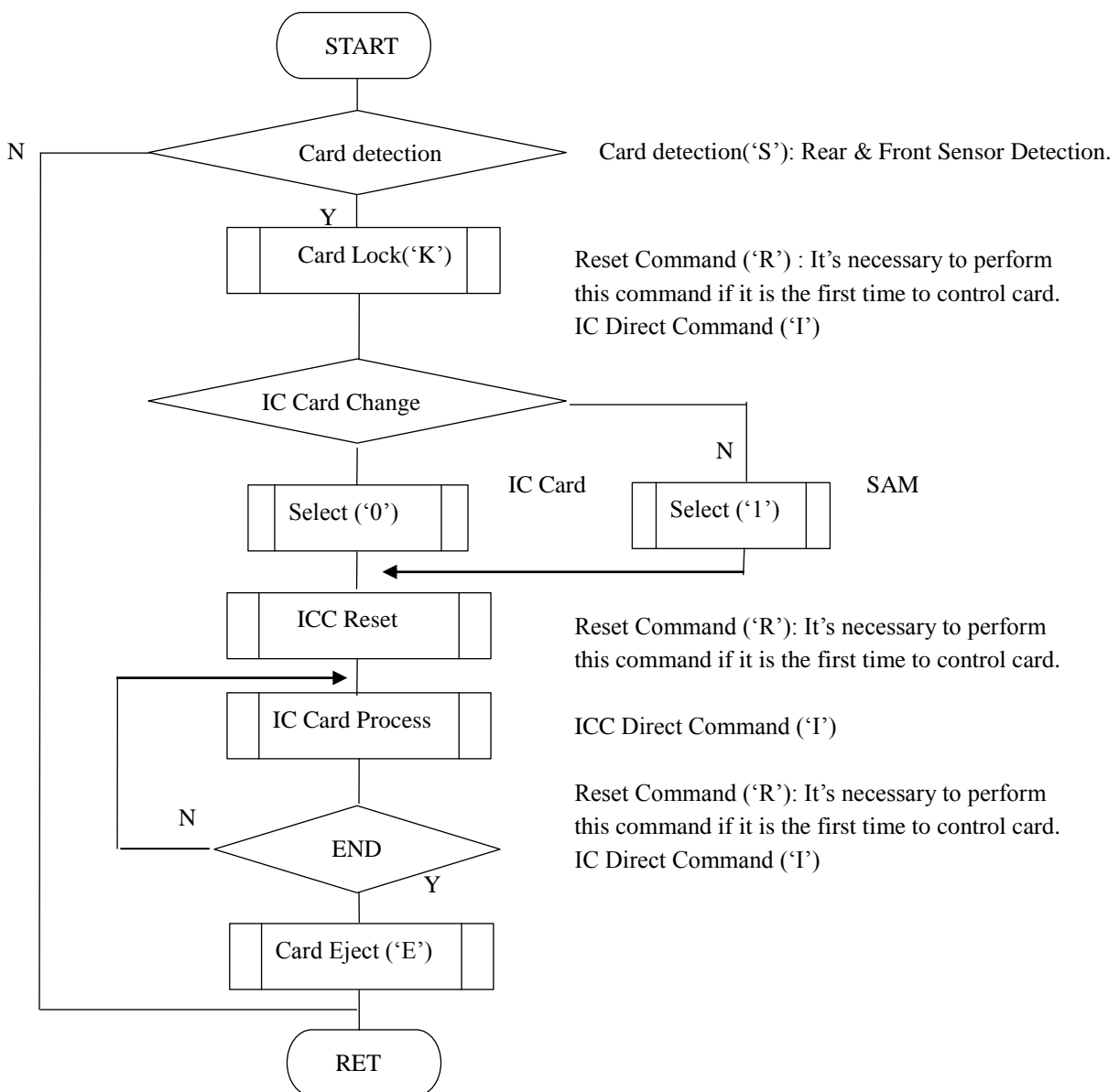

Doc No	KYT74XX SERIES SPECIFICATIONS	REV	PAGE	DATE
		J	21 OF 45	2014. 03 .07.

7.4 M/S Data Reading.

7.4.1 'M' (4DH): A Command to read Magnetic Data.

Command Packet

STX	00H	01H	'M'	ETX	BCC
-----	-----	-----	-----	-----	-----

Positive Response Packet

STX	Len_H	Len_L	'P'	STAT	DATA	ETX	BCC
-----	-------	-------	-----	------	------	-----	-----

DATA:

Track 1 data	00h	Track 2 data	00H	Track 3 data
--------------	-----	--------------	-----	--------------

Cf.) "00h" byte added to classify each track, and transmit 3 Byte ('N', ST1, ST2) every track if Error occur while reading data.

(Page 15 "6. Negative Response Code List")

Negative Response Packet

STX	Len_H	Len_L	'N'	ST1	ST2	ETX	BCC
-----	-------	-------	-----	-----	-----	-----	-----

Magnetic Card Processing Flow (Example)

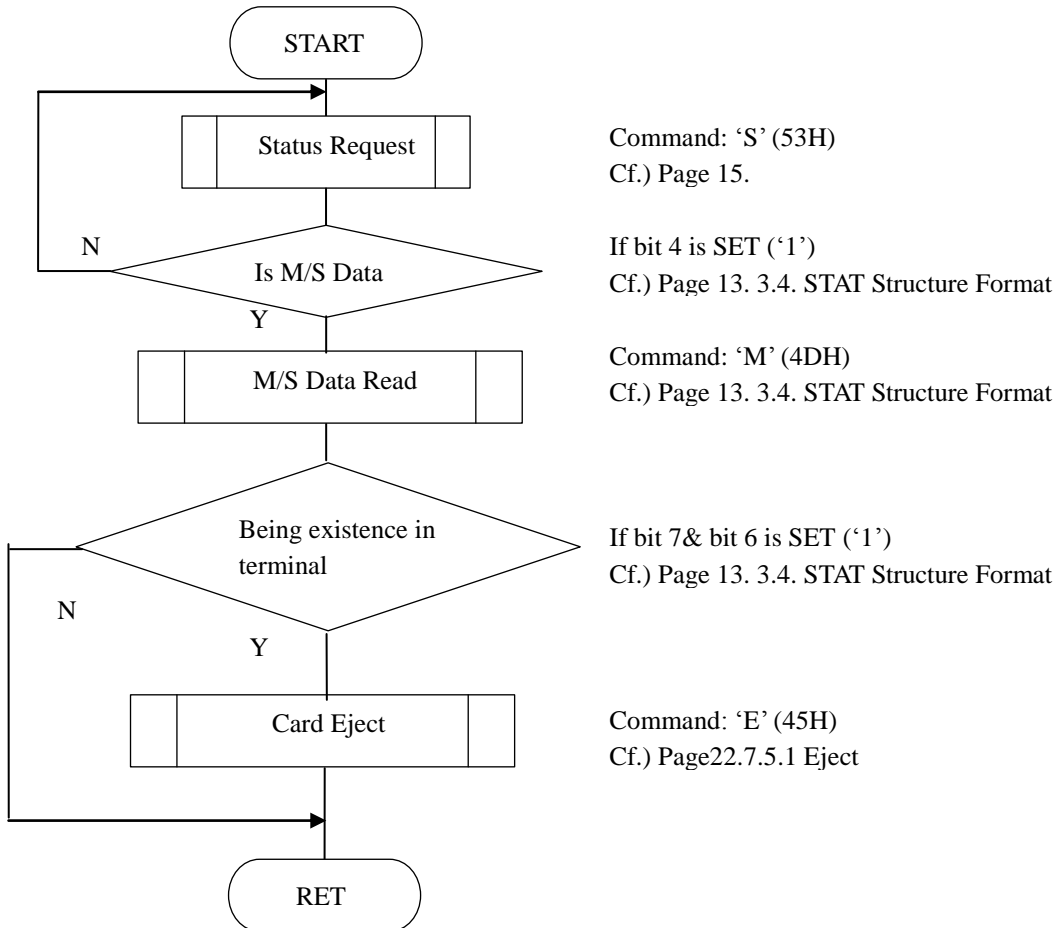

Doc No	KYT74XX SERIES SPECIFICATIONS	REV	PAGE	DATE
		J	22 OF 45	2014. 03 .07.

7.4.2 'C'(43H) : A Command to clear Magnetic data.

Command Packet

STX	00H	01H	'C'	ETX	BCC
-----	-----	-----	-----	-----	-----

Positive Response Packet

STX	Len_H	Len_L	'P'	STAT	ETX	BCC
-----	-------	-------	-----	------	-----	-----

Negative Response Packet

STX	Len_H	Len_L	'N'	ST1	ST2	ETX	BCC
-----	-------	-------	-----	-----	-----	-----	-----

Doc No	KYT74XX SERIES SPECIFICATIONS	REV	PAGE	DATE
		J	23 OF 45	2014. 03 .07.

7.5 Eject & Lock.

7.5.1 'E'(45H) : A Command to eject a card.

If this Command would be executed while a IC Card being in operation inside reader, IC Card is De-Activated and then ejected.

Command Packet

STX	00H	01H	'E'	ETX	BCC
-----	-----	-----	-----	-----	-----

Positive Response Packet

STX	Len_H	Len_L	'P'	STAT	ETX	BCC
-----	-------	-------	-----	------	-----	-----

Negative Response Packet

STX	Len_H	Len_L	'N'	ST1	ST2	ETX	BCC
-----	-------	-------	-----	-----	-----	-----	-----

7.5.2 'K'(4BH) : A Command to lock card.

Command Packet

STX	00H	01H	'K'	ETX	BCC
-----	-----	-----	-----	-----	-----

Positive Response Packet

STX	Len_H	Len_L	'P'	STAT	ETX	BCC
-----	-------	-------	-----	------	-----	-----

Negative Response Packet

STX	Len_H	Len_L	'N'	ST1	ST2	ETX	BCC
-----	-------	-------	-----	-----	-----	-----	-----

7.6 RF Command.

Function	Cm0	Cm1	Cm2	Explanation
Sector/Block Get	'F'	0x30	0x30	Sector/Block Get
Detection.		0x30	0x31	Card Detection.
Sector & Block Setting		0x30	0x32	Sector & Block Setting
Serial Number		0x30	0x33	Get the MIFARE Card Serial Number
Read		0x31	0x30	MIFARE Card Read
Write		0x31	0x31	MIFARE Card Balance Write.
		0x31	0x32	MIFARE Card Character Write
Increment		0x31	0x33	MIFARE Card Increment.
Decrement		0x31	0x34	MIFARE Card Decrement.
Read		0x31	0x35	MIFARE Card Read Balance
Module Key		0x32	0x35	Module Key Value Change
Card Key		0x32	0x31	Card Secret Key Change.
Key Set		0x32	0x32	Authentication Key set
Card Key Change		0x32	0x33	Card Secret Key Change to other Key
		0x32	0x34	Key Value Change(without access code)
Power On		0x33	0x30	The carrier wave emitted in antenna.
Power Off		0x33	0x31	The carrier wave not emitted in antenna.
Read		0x40	0x30	MIFARE Card Read.(Sector, Block, key)
Write		0x40	0x31	MIFARE Card Balance Write. (Sector, Block, key)
		0x40	0x32	MIFARE Card Character Write(Sector, Block, key)
Increment		0x40	0x33	MIFARE Card Increment. (Sector, Block, key)
Decrement		0x40	0x34	MIFARE Card Decrement. (Sector, Block, key)
Read		0x40	0x35	MIFARE Card Read Balance.(Sector, Block, key)

Doc No	KYT74XX SERIES SPECIFICATIONS	REV	PAGE	DATE
		J	24 OF 45	2014. 03 .07.

7.6.1. Sector/Block Get

: Identify the sector and block set at terminal.

Command Packet

STX	Len_H	Len_L	'F'	DATA	ETX	BCC
-----	-------	-------	-----	------	-----	-----

Command DATA Structure

Command[0x30]	Command[0x30]
---------------	---------------

Positive Response Packet

STX	Len_H	Len_L	'P'	STAT	DATA	ETX	BCC
-----	-------	-------	-----	------	------	-----	-----

Negative Response Packet

STX	Len_H	Len_L	'N'	ST1	ST2	ETX	BCC
-----	-------	-------	-----	-----	-----	-----	-----

Response DATA Structure

Sector(1Byte , Hex)	Block(1Byte , Hex)
---------------------	--------------------

7.6.2. Card Detection.

: Identify whether if the antenna detect the card.

Command Format

STX	Len_H	Len_L	'F'	DATA	ETX	BCC
-----	-------	-------	-----	------	-----	-----

Command DATA Structure

Command[0x30]	Command[0x31]
---------------	---------------

Positive Response Packet

STX	Len_H	Len_L	'P'	STAT	DATA	ETX	BCC
-----	-------	-------	-----	------	------	-----	-----

Negative Response Packet

STX	Len_H	Len_L	'N'	ST1	ST2	ETX	BCC
-----	-------	-------	-----	-----	-----	-----	-----

Response Data Structure

Status Mode (1Byte, Hex)

<Status Mode>

Value	Detail
0x01	Card Detection
0x00	Card Non-Detection(= No Card)

7.6.3. Sector & Block Setting

: Change the sector and block set at terminal.

Command Format

STX	Len_H	Len_L	'F'	DATA	ETX	BCC
-----	-------	-------	-----	------	-----	-----

Command DATA Structure

Command[0x30]	Command[0x32]
---------------	---------------

Sector(1Byte , Hex)	Block(1Byte , Hex)
---------------------	--------------------

Note: Sector Range: 0x00 ~ 0x0f, Block Range: 0x00 ~ 0x03.

Positive Response Packet

STX	Len_H	Len_L	'P'	STAT	ETX	BCC
-----	-------	-------	-----	------	-----	-----

Negative Response Packet

STX	Len_H	Len_L	'N'	ST1	ST2	ETX	BCC
-----	-------	-------	-----	-----	-----	-----	-----

Doc No	KYT74XX SERIES SPECIFICATIONS	REV	PAGE	DATE
		J	25 OF 45	2014. 03 .07.

7.6.4. Serial Value

: Get the RF Card's serial number (UID).

↳ Command Format

STX	Len_H	Len_L	'F'	DATA	ETX	BCC
-----	-------	-------	-----	------	-----	-----

↳ Command DATA Structure

Command[0x30]	Command[0x35]
---------------	---------------

↳ Positive Response Packet

STX	Len_H	Len_L	'P'	STAT	DATA	ETX	BCC
-----	-------	-------	-----	------	------	-----	-----

↳ Negative Response Packet

STX	Len_H	Len_L	'N'	ST1	ST2	ETX	BCC
-----	-------	-------	-----	-----	-----	-----	-----

↳ Response Data Structure

Serial Value(4Byte, Hex)

Note: The RF Card's serial consists of 4 Bytes..

7.6.5. Read Block

: Read the data structure (16 Bytes) of the RF Card

Note: Sector Range: 0x00 ~ 0x0f, Block Range: 0x00 ~ 0x03.

↳ Command Format

STX	Len_H	Len_L	'F'	DATA	ETX	BCC
-----	-------	-------	-----	------	-----	-----

↳ Command DATA Structure

Command[0x31]	Command[0x31]
---------------	---------------

↳ Positive Response Packet

STX	Len_H	Len_L	'P'	STAT	DATA	ETX	BCC
-----	-------	-------	-----	------	------	-----	-----

↳ Negative Response Packet

STX	Len_H	Len_L	'N'	ST1	ST2	ETX	BCC
-----	-------	-------	-----	-----	-----	-----	-----

↳ Response DATA Structure

DATA(16Byte, Hex)

7.6.6. Balance Write.

: Write the data at the specified block in the RF Card.

Note: Sector Range: 0x00 ~ 0x0f, Block Range: 0x00 ~ 0x03.

↳ Command Format

STX	Len_H	Len_L	'F'	DATA	ETX	BCC
-----	-------	-------	-----	------	-----	-----

↳ Command DATA Structure

Command[0x31]	Command[0x31]
---------------	---------------

DATA(4Byte, Hex)

↳ Positive Response Packet

STX	Len_H	Len_L	'P'	STAT	ETX	BCC
-----	-------	-------	-----	------	-----	-----

↳ Negative Response Packet

STX	Len_H	Len_L	'N'	ST1	ST2	ETX	BCC
-----	-------	-------	-----	-----	-----	-----	-----

Doc No	KYT74XX SERIES SPECIFICATIONS	REV	PAGE	DATE
		J	26 OF 45	2014. 03 .07.

7.6.7. Character Write.

: Write the data string at the specified block in the RF Card.
 Note: Sector Range: 0x00 ~ 0x0f, Block Range: 0x00 ~ 0x03.

↳ Command Format

STX	Len_H	Len_L	'F'	DATA	ETX	BCC
-----	-------	-------	-----	------	-----	-----

↳ Command DATA Structure

Command[0x31]	Command[0x32]
---------------	---------------

DATA(16Byte, Hex)

Cf)DATA : "1234567890123456"

MSB	LSB
0x31 0x32 0x33	0x35 0x36

↳ Positive Response Packet

STX	Len_H	Len_L	'P'	STAT	ETX	BCC
-----	-------	-------	-----	------	-----	-----

↳ Negative Response Packet

STX	Len_H	Len_L	'N'	ST1	ST2	ETX	BCC
-----	-------	-------	-----	-----	-----	-----	-----

7.6.8. Increment.

: Increase the RF Card's Balance as much as a given data value.

Note: Sector Range: 0x00 ~ 0x0f, Block Range: 0x00 ~ 0x02.

↳ Command Format

STX	Len_H	Len_L	'F'	DATA	ETX	BCC
-----	-------	-------	-----	------	-----	-----

↳ Command DATA Structure

Command[0x31]	Command[0x33]
---------------	---------------

↳ Command DATA Structure

DATA(4Byte, Hex)

↳ Positive Response Packet

STX	Len_H	Len_L	'P'	STAT	ETX	BCC
-----	-------	-------	-----	------	-----	-----

↳ Negative Response Packet

STX	Len_H	Len_L	'N'	ST1	ST2	ETX	BCC
-----	-------	-------	-----	-----	-----	-----	-----

7.6.9. Decrement

: Decrease the RF Card's Balance as much as a given data value.

Note: Sector Range: 0x00 ~ 0x0f, Block Range: 0x00 ~ 0x02.

↳ Command Format

STX	Len_H	Len_L	'F'	DATA	ETX	BCC
-----	-------	-------	-----	------	-----	-----

↳ Command DATA Structure

Command[0x31]	Command[0x34]
---------------	---------------

↳ Command DATA Structure

DATA(4Byte, Hex)

↳ Positive Response Packet

STX	Len_H	Len_L	'P'	STAT	ETX	BCC
-----	-------	-------	-----	------	-----	-----

↳ Negative Response Packet

STX	Len_H	Len_L	'N'	ST1	ST2	ETX	BCC
-----	-------	-------	-----	-----	-----	-----	-----

Doc No	KYT74XX SERIES SPECIFICATIONS	REV	PAGE	DATE
		J	27 OF 45	2014. 03 .07.

7.6.10. Read Balance

: Read the RF Card's Balance.

Note: Sector Range: 0x00~ 0x0f, Block Range: 0x01 ~ 0x02.

↳ Command Format

STX	Len_H	Len_L	'F'	DATA	ETX	BCC
-----	-------	-------	-----	------	-----	-----

↳ Command DATA Structure

Command[0x31]	Command[0x35]
---------------	---------------

↳ Positive Response Packet

STX	Len_H	Len_L	'P'	STAT	DATA	ETX	BCC
-----	-------	-------	-----	------	------	-----	-----

↳ Negative Response Packet

STX	Len_H	Len_L	'N'	ST1	ST2	ETX	BCC
-----	-------	-------	-----	-----	-----	-----	-----

↳ Response DATA Structure

DATA(4Byte, Hex)

7.6.11. Module Key Value Change

: Change the RF Card Key Value required for authentication.

↳ Command Format

STX	Len_H	Len_L	'F'	DATA	ETX	BCC
-----	-------	-------	-----	------	-----	-----

↳ Command DATA Structure

Command[0x32]	Command[0x30]
---------------	---------------

Sector	Key 1	KEY A	KEY B	Key 2	KEY A	KEY B	Key 3	KEY A	KEY B
--------	-------	-------	-------	-------	-------	-------	-------	-------	-------

Sector	Key1	KEY A	KEY B
Sector(1Byte, Hex)	Key(1Byte, Hex)	DATA (6Byte, Hex)	DATA (6Byte,Hex)

Sector : 0x00 ~ 0x0f, All Sector : 0xff

* Key Name

Key Location	Value
Key 1	0x01
Key 2	0x02
Key 3	0x03

KEYA, KEYB : Authentication Key data.

↳ Positive Response Packet

STX	Len_H	Len_L	'P'	STAT	ETX	BCC
-----	-------	-------	-----	------	-----	-----

↳ Negative Response Packet

STX	Len_H	Len_L	'N'	ST1	ST2	ETX	BCC
-----	-------	-------	-----	-----	-----	-----	-----

Doc No	KYT74XX SERIES SPECIFICATIONS	REV	PAGE	DATE
		J	28 OF 45	2014. 03 .07.

7.6.12. Card Secret Key Change.

: Change the RF Card Key Value.

↳ Command Format

STX	Len_H	Len_L	'F'	DATA	ETX	BCC
-----	-------	-------	-----	------	-----	-----

↳ Command DATA Structure

Command[0x32]	Command[0x31]
---------------	---------------

↳ Command DATA Structure

Sector(1Byte, Hex)	KEYA(6Byte, Hex)	KEYB(6Byte,Hex)
--------------------	------------------	-----------------

Sector (0x00 ~ 0x0f)

↳ Positive Response Packet

STX	Len_H	Len_L	'P'	STAT	ETX	BCC
-----	-------	-------	-----	------	-----	-----

↳ Negative Response Packet

STX	Len_H	Len_L	'N'	ST1	ST2	ETX	BCC
-----	-------	-------	-----	-----	-----	-----	-----

7.6.13. Authentication Key.

: Select the authentication key(Key A, Key B).

↳ Command Format

STX	Len_H	Len_L	'F'	DATA	ETX	BCC
-----	-------	-------	-----	------	-----	-----

↳ Command DATA Structure

Command[0x32]	Command[0x32]
---------------	---------------

<Key Select>

7	6	5	4	3	2	1	0
0	0	0	0	0	0	x	x

Low(4bit)	Detail
0x00	Key A
0x01	Key B

↳ Positive Response Packet

STX	Len_H	Len_L	'P'	STAT	ETX	BCC
-----	-------	-------	-----	------	-----	-----

↳ Negative Response Packet

STX	Len_H	Len_L	'N'	ST1	ST2	ETX	BCC
-----	-------	-------	-----	-----	-----	-----	-----

7.6.14. Card Secret Key Change to other Key

: Change the RF Card Key Value.

↳ Command Format

STX	Len_H	Len_L	'F'	DATA	ETX	BCC
-----	-------	-------	-----	------	-----	-----

↳ Command DATA Structure

Command[0x32]	Command[0x33]
---------------	---------------

Sector(1Byte, Hex)	KEYA(6Byte, Hex)	Access(4Byte, Hex)	KEYB(6Byte,Hex)
--------------------	------------------	--------------------	-----------------

Sector (0x00 ~ 0x0F)

↳ Positive Response Packet

STX	Len_H	Len_L	'P'	STAT	ETX	BCC
-----	-------	-------	-----	------	-----	-----

↳ Negative Response Packet

STX	Len_H	Len_L	'N'	ST1	ST2	ETX	BCC
-----	-------	-------	-----	-----	-----	-----	-----

Doc No	KYT74XX SERIES SPECIFICATIONS	REV	PAGE	DATE
		J	29 OF 45	2014. 03 .07.

7.6.15 Key Value Change

: Change the RF Card Key Value required for authentication.

↳ Command Format

STX	Len_H	Len_L	'F'	DATA	ETX	BCC
-----	-------	-------	-----	------	-----	-----

↳ Command DATA Structure

Command[0x32]	Command[0x34]
---------------	---------------

Key(1Byte, Hex)	Sector(1Byte, Hex)	DATA (6Byte, Hex)	DATA (6Byte,Hex)
-----------------	--------------------	-------------------	------------------

* Key Name

Key Location	Value
Key 0	0x01

* Sector (1Byte, Hex) : 0x00 ~ 0x0F

↳ Positive Response Packet

STX	Len_H	Len_L	'P'	STAT	ETX	BCC
-----	-------	-------	-----	------	-----	-----

↳ Negative Response Packet

STX	Len_H	Len_L	'N'	ST1	ST2	ETX	BCC
-----	-------	-------	-----	-----	-----	-----	-----

7.6.16. Power On.

: The carrier wave emitted in antenna.

↳ Command Format

STX	Len_H	Len_L	'F'	DATA	ETX	BCC
-----	-------	-------	-----	------	-----	-----

↳ Command DATA Structure

Command[0x33]	Command[0x30]
---------------	---------------

↳ Positive Response Packet

STX	Len_H	Len_L	'P'	STAT	ETX	BCC
-----	-------	-------	-----	------	-----	-----

↳ Negative Response Packet

STX	Len_H	Len_L	'N'	ST1	ST2	ETX	BCC
-----	-------	-------	-----	-----	-----	-----	-----

7.6.17. Power Off

: The carrier wave not emitted in antenna.

↳ Command Format

STX	Len_H	Len_L	'F'	DATA	ETX	BCC
-----	-------	-------	-----	------	-----	-----

↳ Command DATA Structure

Command[0x33]	Command[0x31]
---------------	---------------

↳ Positive Response Packet

STX	Len_H	Len_L	'P'	STAT	ETX	BCC
-----	-------	-------	-----	------	-----	-----

↳ Negative Response Packet

STX	Len_H	Len_L	'N'	ST1	ST2	ETX	BCC
-----	-------	-------	-----	-----	-----	-----	-----

Doc No	KYT74XX SERIES SPECIFICATIONS	REV	PAGE	DATE
		J	30 OF 45	2014. 03 .07.

7.6.18. Read Block.

: Read the data structure (16 Bytes) of the RF Card

↳ Command Format

STX	Len_H	Len_L	'F'	DATA	ETX	BCC
-----	-------	-------	-----	------	-----	-----

↳ Command DATA Structure

Command[0x34]	Command[0x30]
---------------	---------------

KEY Type	Sector (1Byte , Hex)	Block (1Byte , Hex)	Secret Key(6Byte, Hex)
----------	----------------------	---------------------	------------------------

KEY Type : KEYA(0x00), KEYB(0x01) , Sector : 0x00 ~ 0x0f, Block : 0x00 ~ 0x03, Secret Key(6byte).

↳ Positive Response Packet

STX	Len_H	Len_L	'P'	STAT	DATA	ETX	BCC
-----	-------	-------	-----	------	------	-----	-----

↳ Negative Response Packet

STX	Len_H	Len_L	'N'	ST1	ST2	ETX	BCC
-----	-------	-------	-----	-----	-----	-----	-----

↳ Response DATA Structure

DATA(16Byte, Hex)

7.6.19. Balance Write.

: Write the data at the specified block in the RF Card.

↳ Command Format

STX	Len_H	Len_L	'F'	DATA	ETX	BCC
-----	-------	-------	-----	------	-----	-----

↳ Command DATA Structure

Command[0x34]	Command[0x31]
---------------	---------------

KEY Type	Sector (1Byte , Hex)	Block (1Byte , Hex)	Secret Key(6Byte, Hex)
----------	----------------------	---------------------	------------------------

Balance Data (4Byte, Hex)

KEY Type : KEYA(0x00), KEYB(0x01) , Sector : 0x00 ~ 0x0f, Block : 0x00 ~ 0x03, Secret Key(6byte).

↳ Positive Response Packet

STX	Len_H	Len_L	'P'	STAT	ETX	BCC
-----	-------	-------	-----	------	-----	-----

↳ Negative Response Packet

STX	Len_H	Len_L	'N'	ST1	ST2	ETX	BCC
-----	-------	-------	-----	-----	-----	-----	-----

Doc No	KYT74XX SERIES SPECIFICATIONS	REV	PAGE	DATE
		J	31 OF 45	2014. 03 .07.

7.6.20. Character Write.

: Write the data string at the specified block in the RF Card.

↳ Command Format

STX	Len_H	Len_L	'F'	DATA	ETX	BCC
-----	-------	-------	-----	------	-----	-----

↳ Command DATA Structure

Command[0x34]	Command[0x32]
---------------	---------------

KEY Type	Sector (1Byte , Hex)	Block (1Byte , Hex)	Secret Key(6Byte, Hex)
----------	----------------------	---------------------	------------------------

DATA(16Byte, Hex)

KEY Type: KEYA (0x00), KEYB (0x01), Sector: 0x00 ~ 0x0f, Block: 0x00 ~ 0x03, Secret Key (6byte).

Cf.) DATA: "1234567890123456"

MSB	LSB
0x31 0x32 0x33	0x35 0x36

↳ Positive Response Packet

STX	Len_H	Len_L	'P'	STAT	ETX	BCC
-----	-------	-------	-----	------	-----	-----

↳ Negative Response Packet

STX	Len_H	Len_L	'N'	ST1	ST2	ETX	BCC
-----	-------	-------	-----	-----	-----	-----	-----

7.6.21. Increment.

: Increase the RF Card's Balance as much as a given data value.

↳ Command Format

STX	Len_H	Len_L	'F'	DATA	ETX	BCC
-----	-------	-------	-----	------	-----	-----

↳ Command DATA Structure

Command[0x34]	Command[0x33]
---------------	---------------

KEY Type	Sector (1Byte , Hex)	Block (1Byte , Hex)	Secret Key(6Byte, Hex)
----------	----------------------	---------------------	------------------------

Balance Data (4Byte, Hex)

KEY Type: KEY A(0x00), KEY B(0x01) , Sector : 0x00 ~ 0x0f, Block : 0x00 ~ 0x03, Secret Key(6byte).

↳ Positive Response Packet

STX	Len_H	Len_L	'P'	STAT	ETX	BCC
-----	-------	-------	-----	------	-----	-----

↳ Negative Response Packet

STX	Len_H	Len_L	'N'	ST1	ST2	ETX	BCC
-----	-------	-------	-----	-----	-----	-----	-----

Doc No	KYT74XX SERIES SPECIFICATIONS	REV	PAGE	DATE
		J	32 OF 45	2014. 03 .07.

7.6.21. Decrement

: Decrease the RF Card's Balance as much as a given data value.

↳ Command Format

STX	Len_H	Len_L	'F'	DATA	ETX	BCC
-----	-------	-------	-----	------	-----	-----

↳ Command DATA Structure

Command[0x34]	Command[0x34]
---------------	---------------

KEY Type	Sector (1Byte , Hex)	Block (1Byte , Hex)	Secret Key(6Byte, Hex)
Balance Data (4Byte, Hex)			

KEY Type : KEYA(0x00), KEYB(0x01) , Sector : 0x00 ~ 0x0f, Block : 0x00 ~ 0x03, Secret Key(6byte).

↳ Positive Response Packet

STX	Len_H	Len_L	'P'	STAT	ETX	BCC
-----	-------	-------	-----	------	-----	-----

↳ Negative Response Packet

STX	Len_H	Len_L	'N'	ST1	ST2	ETX	BCC
-----	-------	-------	-----	-----	-----	-----	-----

7.6.22. Read Balance

: Read the RF Card's Balance.

↳ Command Format

STX	Len_H	Len_L	'F'	DATA	ETX	BCC
-----	-------	-------	-----	------	-----	-----

↳ Command DATA Structure

Command[0x34]	Command[0x35]
---------------	---------------

KEY Type	Sector (1Byte , Hex)	Block (1Byte , Hex)	Secret Key(6Byte, Hex)
----------	----------------------	---------------------	------------------------

KEY Type : KEYA(0x00), KEYB(0x01) , Sector : 0x00 ~ 0x0f, Block : 0x00 ~ 0x03, Secret Key(6byte).

↳ Positive Response Packet

STX	Len_H	Len_L	'P'	STAT	DATA	ETX	BCC
-----	-------	-------	-----	------	------	-----	-----

↳ Negative Response Packet

STX	Len_H	Len_L	'N'	ST1	ST2	ETX	BCC
-----	-------	-------	-----	-----	-----	-----	-----

↳ Response DATA Structure

DATA(4Byte, Hex)

7.6.23. LED On/Off.

↳ Command Format

STX	Len_H	Len_L	'F'	DATA	ETX	BCC
-----	-------	-------	-----	------	-----	-----

↳ Command DATA Structure

Command[0x35]	Command[0x30]
---------------	---------------

LED [1BYTE]

. 0x30: REEN_LED ON . 0x31: RED_LED ON . 0x32: ORANGE_LED ON

. 0x33: ALL OFF

↳ Positive Response Packet

STX	Len_H	Len_L	'P'	STAT	DATA	ETX	BCC
-----	-------	-------	-----	------	------	-----	-----

↳ Negative Response Packet

STX	Len_H	Len_L	'N'	ST1	ST2	ETX	BCC
-----	-------	-------	-----	-----	-----	-----	-----

Doc No	KYT74XX SERIES SPECIFICATIONS	REV	PAGE	DATE
		J	33 OF 45	2014. 03 .07.

EXECUTION PROCEDURES

This is a flowchart that describes how to operate the read, write, increment and decrement command after detecting the card. However, it is possible to read, write, increase and decrease without detecting a card.

1. Card Key change, Access Key change Function.

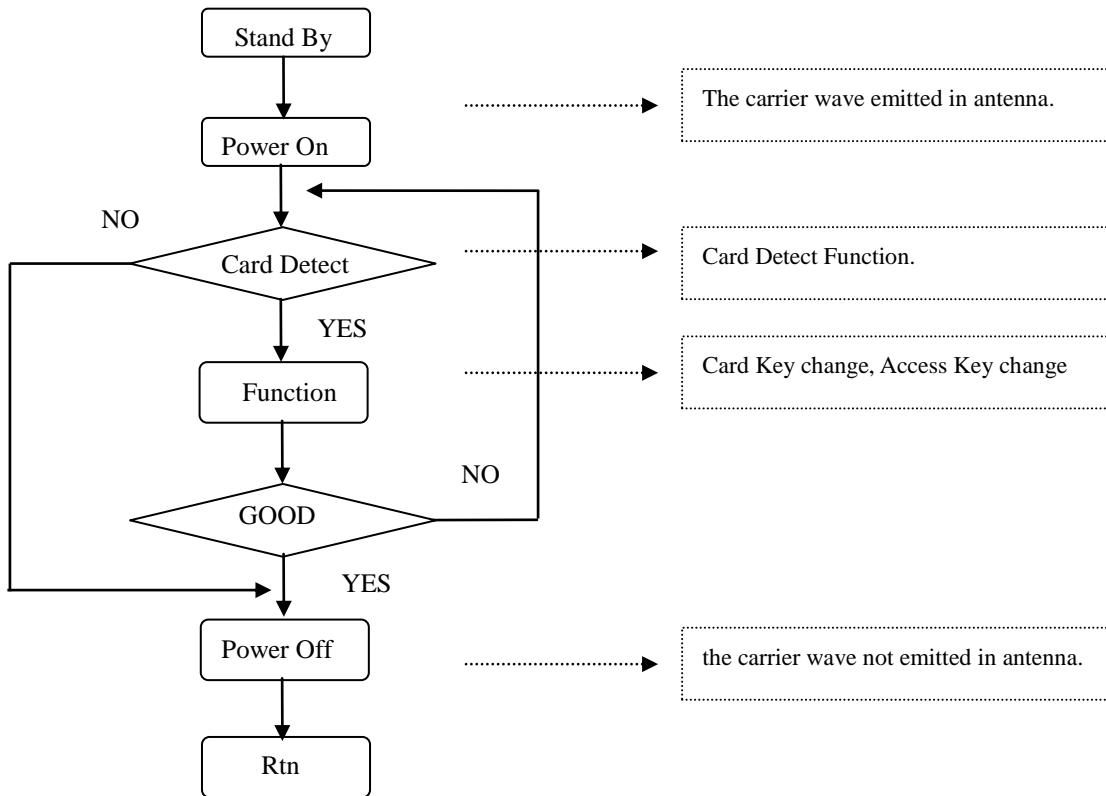

Doc No	KYT74XX SERIES SPECIFICATIONS	REV	PAGE	DATE
		J	34 OF 45	2014. 03 .07.

2. Authentication Key Function.

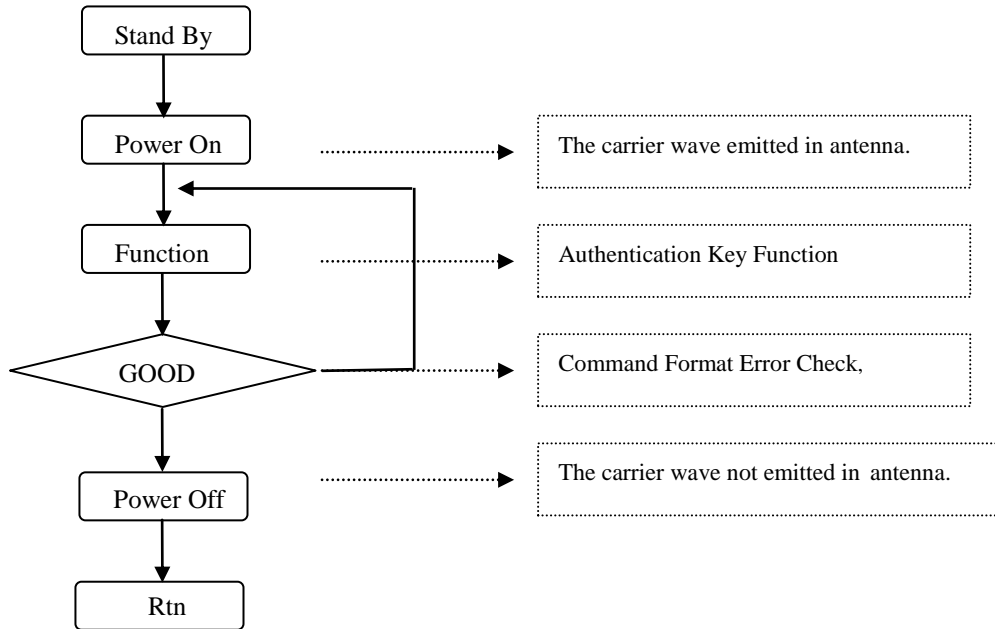

Doc No	KYT74XX SERIES SPECIFICATIONS	REV	PAGE	DATE
		J	35 OF 45	2014. 03 .07.

3. Read/Write, Increment/Decrement, Balance Write/ Balance Read

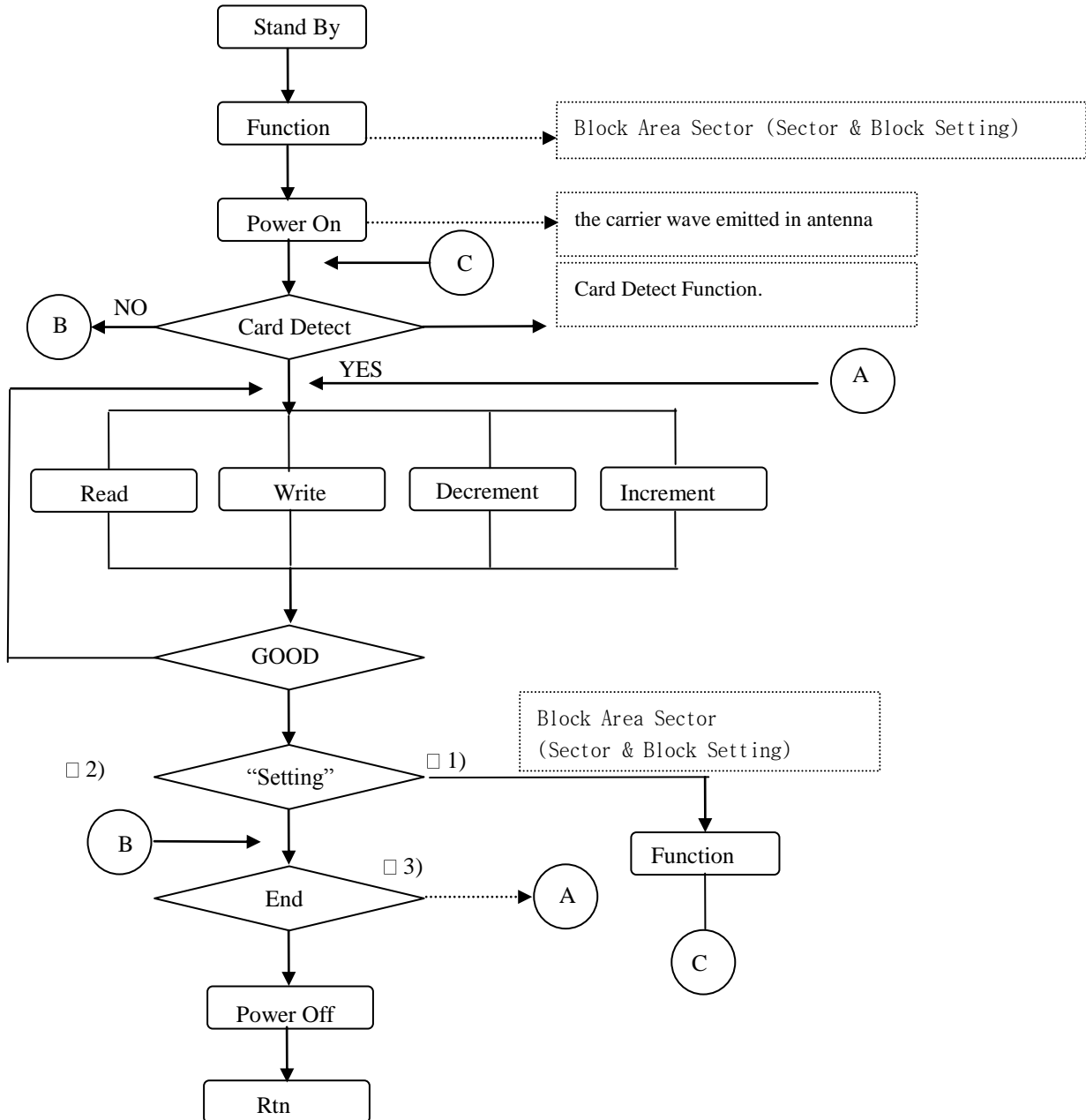

- 1: "Setting" is for new Sector or Block, not previous Sector or Block
- 2: Confirm all the process for present card is completed.
- 3: the carrier wave not emitted in antenna

Doc No	KYT74XX SERIES SPECIFICATIONS	REV	PAGE	DATE
		J	36 OF 45	2014. 03 .07.

7.7 Memory Card.

7.7.1 SLE 4442(SLE 5542)

The Command is for communication with the IC card(SLE 5542) and it is available after executing ATR command(Z00). To read or write data on an IC card in hexa value, the start address is necessary which is available for 00h ~ FFh As “len is the length of data to read or write from start address , start address data length” should not be more than FFh.

EXECUTION PROCEDURES

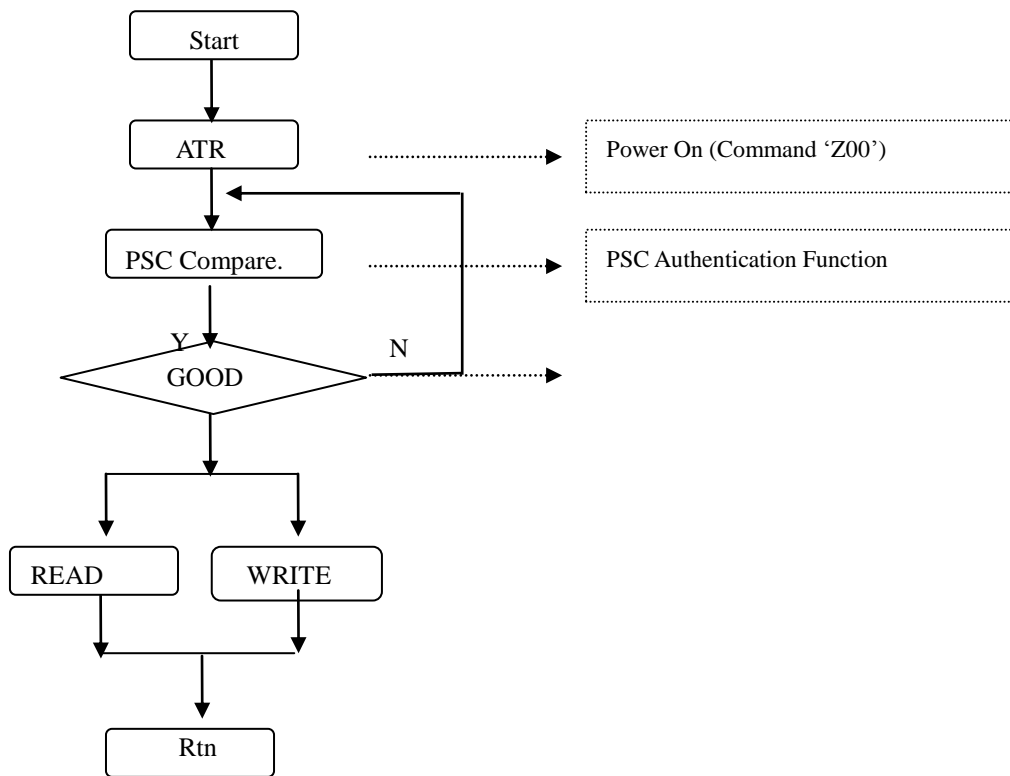

Doc No	KYT74XX SERIES SPECIFICATIONS	REV	PAGE	DATE
		J	37 OF 45	2014. 03 .07.

* Memory Map.

Address (decimal)	Main Memory	Protection Memory	Security Memory (only SLE 4442)
255	Data Byte 255 (D7 ... D0)		
:	:		
32	Data Byte 32 (D7 ... D0)		
31	Data Byte 31 (D7 ... D0)	Protection Bit 31 (D31)	
:	:	:	
3	Data Byte 3 (D7 ... D0)	Protection Bit 3 (D3)	Reference Data Byte 3 (D7 ... D0)
2	Data Byte 2 (D7 ... D0)	Protection Bit 2 (D2)	Reference Data Byte 2 (D7 ... D0)
1	Data Byte 1 (D7 ... D0)	Protection Bit 1 (D1)	Reference Data Byte 1 (D7 ... D0)
0	Data Byte 0 (D7 ... D0)	Protection Bit 0 (D0)	Error Counter (0,0,0,0,0,D2,D1,D0)

A) 'Z00': Command for sending Reset Signal Contacted IC Card and for receiving ATR from IC Card (SLE4428 or SLE4442).

Command Packet

STX	Len_H	Len_L	'Z'	DATA	ETX	BCC
-----	-------	-------	-----	------	-----	-----

Command DATA Structure

Command[0x30]	Command[0x30]
---------------	---------------

Positive Response Packet

STX	Len_H	Len_L	'P'	STAT	DATA	ETX	BCC
-----	-------	-------	-----	------	------	-----	-----

Negative Response Packet

STX	Len_H	Len_L	'N'	ST1	ST2	ETX	BCC
-----	-------	-------	-----	-----	-----	-----	-----

Response DATA Structure

(4Byte , Hex)

Example

EX) SLE 4442

0xA2	0x13	0x10	0x91
------	------	------	------

EX) SLE 4428

0x92	0x23	0x10	0x91
------	------	------	------

B) 'Z09': Power OFF.

Command Format

STX	Len_H	Len_L	'Z'	DATA	ETX	BCC
-----	-------	-------	-----	------	-----	-----

Command DATA Structure

Command[0x30]	Command[0x39]
---------------	---------------

Positive Response Packet

STX	Len_H	Len_L	'P'	STAT	ETX	BCC
-----	-------	-------	-----	------	-----	-----

Negative Response Packet

STX	Len_H	Len_L	'N'	ST1	ST2	ETX	BCC
-----	-------	-------	-----	-----	-----	-----	-----

Doc No	KYT74XX SERIES SPECIFICATIONS	REV	PAGE	DATE
		J	38 OF 45	2014. 03 .07.

c) 'Z01': PSC Compare.

- This command should be done before writing data if the input PSC code is different from the original PSC Code, the value at 00h of security memory will be down counted in bit and if the value of 00h be come '0' after 3 time of input the IC card will not be valid any more.

Therefore error count should be checked when this command is performed.

Command Packet

STX	Len_H	Len_L	'Z'	DATA	ETX	BCC
-----	-------	-------	-----	------	-----	-----

Command DATA Structure

Command[0x30]	Command[0x31]	PSC1	PSC2	PSC3
---------------	---------------	------	------	------

Positive Response Packet

STX	Len_H	Len_L	'P'	STAT	DATA	ETX	BCC
-----	-------	-------	-----	------	------	-----	-----

Negative Response Packet

STX	Len_H	Len_L	'N'	ST1	ST2	ETX	BCC
-----	-------	-------	-----	-----	-----	-----	-----

Response DATA Structure

(1Byte , Hex)

*Error Count.

- 0x07: Compare Good,
- 0x06: Wrong One Time, 0x04: Wrong Two Time, 0x00: Locked the Card.

d) 'Z02': PSC Modify.

This is command to modify PSC after executing PSC Compare command.

PSC Compare must be executed after PSC modification is done.

Command Packet

STX	Len_H	Len_L	'Z'	DATA	ETX	BCC
-----	-------	-------	-----	------	-----	-----

Command DATA Structure

Command[0x30]	Command[0x32]	PSC1	PSC2	PSC3
---------------	---------------	------	------	------

Positive Response Packet

STX	Len_H	Len_L	'P'	STAT	ETX	BCC
-----	-------	-------	-----	------	-----	-----

Negative Response Packet

STX	Len_H	Len_L	'N'	ST1	ST2	ETX	BCC
-----	-------	-------	-----	-----	-----	-----	-----

Response DATA Structure

(3Byte , Hex)

Doc No	KYT74XX SERIES SPECIFICATIONS	REV	PAGE	DATE
		J	39 OF 45	2014. 03 .07.

E) 'Z03': PSC Read.

This is the command to read security memory where PSC error and PSC are existed.

Command Packet

STX	Len_H	Len_L	'Z'	DATA	ETX	BCC
-----	-------	-------	-----	------	-----	-----

Command DATA Structure

Command[0x30]	Command[0x33]
---------------	---------------

Positive Response Packet

STX	Len_H	Len_L	'P'	STAT	DATA	ETX	BCC
-----	-------	-------	-----	------	------	-----	-----

Negative Response Packet

STX	Len_H	Len_L	'N'	ST1	ST2	ETX	BCC
-----	-------	-------	-----	-----	-----	-----	-----

Response DATA Structure

Error Count	PSC1(1 Byte , Hex)	PSC2(1 Byte , Hex)	PSC3(1 Byte , Hex)
-------------	--------------------	--------------------	--------------------

F) 'Z04': Read Memory.

This command is to read main memory data.

Command Packet

STX	Len_H	Len_L	'Z'	DATA	ETX	BCC
-----	-------	-------	-----	------	-----	-----

Command DATA Structure

Command[0x30]	Command[0x34]	Start Addr[2 BYTE]	End Addr[2 BYTE]
---------------	---------------	--------------------	------------------

Positive Response Packet

STX	Len_H	Len_L	'P'	STAT	DATA	ETX	BCC
-----	-------	-------	-----	------	------	-----	-----

Negative Response Packet

STX	Len_H	Len_L	'N'	ST1	ST2	ETX	BCC
-----	-------	-------	-----	-----	-----	-----	-----

Response DATA Structure

((End addr – Start addr + 1)Byte , Hex)

G) 'Z05': Read The Protection Bit.

This command is to read Protection memory data.

Command Packet

STX	Len_H	Len_L	'Z'	DATA	ETX	BCC
-----	-------	-------	-----	------	-----	-----

Command DATA Structure

Command[0x30]	Command[0x35]
---------------	---------------

Positive Response Packet

STX	Len_H	Len_L	'P'	STAT	DATA	ETX	BCC
-----	-------	-------	-----	------	------	-----	-----

Negative Response Packet

STX	Len_H	Len_L	'N'	ST1	ST2	ETX	BCC
-----	-------	-------	-----	-----	-----	-----	-----

Response DATA Structure

Protection Bit(4Byte, Hex)

Doc No	KYT74XX SERIES SPECIFICATIONS	REV	PAGE	DATE
		J	40 OF 45	2014. 03 .07.

H) 'Z06': Full write same character to the Memory without protect.

This command is to write memory data from 0x0020 to 0x00FF.

Command Packet

STX	Len_H	Len_L	'Z'	DATA	ETX	BCC
-----	-------	-------	-----	------	-----	-----

Command DATA Structure

Command[0x30]	Command[0x36]	Write Data [1BYTE]
---------------	---------------	--------------------

Positive Response Packet

STX	Len_H	Len_L	'P'	STAT	DATA	ETX	BCC
-----	-------	-------	-----	------	------	-----	-----

Negative Response Packet

STX	Len_H	Len_L	'N'	ST1	ST2	ETX	BCC
-----	-------	-------	-----	-----	-----	-----	-----

I) 'Z07': Write to the Memory.

This command is to write memory data.

Command Packet

STX	Len_H	Len_L	'Z'	DATA	ETX	BCC
-----	-------	-------	-----	------	-----	-----

Command DATA Structure

Command[0x30]	Command[0x37]	Start Addr[2 BYTE]	End Addr[2 BYTE]
Write Data			

- Write DATA Length : (End Addr - Start Addr + 1) BYTE

Positive Response Packet

STX	Len_H	Len_L	'P'	STAT	DATA	ETX	BCC
-----	-------	-------	-----	------	------	-----	-----

Negative Response Packet

STX	Len_H	Len_L	'N'	ST1	ST2	ETX	BCC
-----	-------	-------	-----	-----	-----	-----	-----

J) 'Z08': Write The Protection Bit.

This command is to write with protection to prevent over-writing.

This command can write on the area where the new data and exist data are same among protected Memories.

Command Packet

STX	Len_H	Len_L	'Z'	DATA	ETX	BCC
-----	-------	-------	-----	------	-----	-----

Command DATA Structure

Command[0x30]	Command[0x38]	Start Addr[2 BYTE]	End Addr[2 BYTE]
Write Data			

- Write DATA Length : (End Addr - Start Addr + 1) BYTE

Positive Response Packet

STX	Len_H	Len_L	'P'	STAT	DATA	ETX	BCC
-----	-------	-------	-----	------	------	-----	-----

Negative Response Packet

STX	Len_H	Len_L	'N'	ST1	ST2	ETX	BCC
-----	-------	-------	-----	-----	-----	-----	-----

Ex) When Write the Protection Memory area Address 0x0010 to 0x0012, Start Address: 0x0010, End Address: 0x0012, Input the Protection Data 3Byte continuously.

Doc No	KYT74XX SERIES SPECIFICATIONS	REV	PAGE	DATE
		J	41 OF 45	2014. 03 .07.

7.7.2 SLE 4428(SLE 5528)

The chip contains an EEPROM organized 1024 x 8 bit offering the possibility of programmable write protection for each byte. Reading of the whole memory is always possible. The memory can be written and erased byte by byte. Input data and the contents of the addressed byte are compared so that only bits are written which were not written before. Erasing is only possible byte-wise, even if only one bit is to be erased, but bits may be written individually. Each byte can be write/erase protected individually by setting a protect bit (EEPROM → ROM). The protect bit is only one time programmable and cannot be erased.

All the memory, except

for the PSC, can always be read. The memory can be written or erased only after PSC verification.

The error counter can always be written. After eight successive incorrect entries the error counter will block any subsequent attempt at PSC verification and hence any possibility to write and erase.

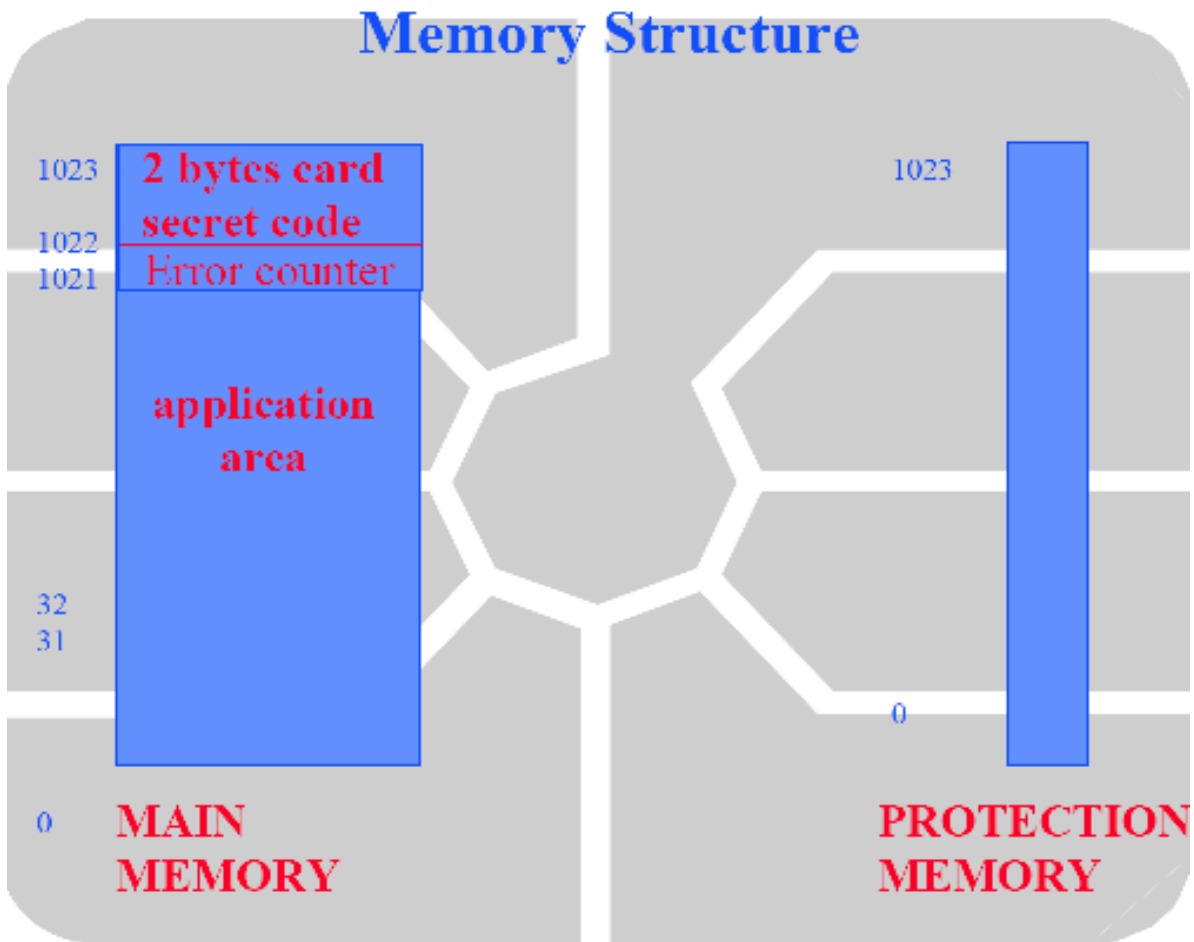

Doc No	KYT74XX SERIES SPECIFICATIONS	REV	PAGE	DATE
		J	42 OF 45	2014. 03 .07.

A) **'Z11': PSC Compare.**

- This command should be done before writing data if the input PSC code is different from the original PSC Code, the value at 00h of security memory will be down counted in bit and if the value of 00h become '0' after 7 time of input the IC card will not be valid any more.

Therefore error count should be checked when this command is performed.

Command Packet

STX	Len_H	Len_L	'Z	DATA	ETX	BCC
-----	-------	-------	----	------	-----	-----

Command DATA Structure

Command[0x31]	Command[0x31]	PSC1	PSC2
---------------	---------------	------	------

Positive Response Packet

STX	Len_H	Len_L	'P'	STAT	DATA	ETX	BCC
-----	-------	-------	-----	------	------	-----	-----

Negative Response Packet

STX	Len_H	Len_L	'N'	ST1	ST2	ETX	BCC
-----	-------	-------	-----	-----	-----	-----	-----

Response DATA Structure

(1Byte , Hex)

*Error Count.

0xFF: Compare Good, 0x3F: Wrong 1 Time, 0x1F: Wrong 2 Time, 0x0F: Wrong 3 Time,
0x07: Wrong 4 Time, 0x03: Wrong 5 Time, 0x01: Wrong 6 Time, 0x00: Locked the Card.

B) **'Z12': PSC Modify.**

This is command to modify PSC after executing PSC Compare command.

PSC Compare must be executed after PSC modification is done.

Command Packet

STX	Len_H	Len_L	'Z	DATA	ETX	BCC
-----	-------	-------	----	------	-----	-----

Command DATA Structure

Command[0x31]	Command[0x32]	PSC1	PSC2
---------------	---------------	------	------

Positive Response Packet

STX	Len_H	Len_L	'P'	STAT	DATA	ETX	BCC
-----	-------	-------	-----	------	------	-----	-----

Negative Response Packet

STX	Len_H	Len_L	'N'	ST1	ST2	ETX	BCC
-----	-------	-------	-----	-----	-----	-----	-----

Response DATA Structure

(2Byte , Hex)

Doc No	KYT74XX SERIES SPECIFICATIONS	REV	PAGE	DATE
		J	43 OF 45	2014. 03 .07.

C) **'Z13': PSC Read.**

This is the command to read security memory where PSC error and PSC are existed.

Command Packet

STX	Len_H	Len_L	'Z'	DATA	ETX	BCC
-----	-------	-------	-----	------	-----	-----

Command DATA Structure

Command[0x31]	Command[0x33]
---------------	---------------

Positive Response Packet

STX	Len_H	Len_L	'P'	STAT	DATA	ETX	BCC
-----	-------	-------	-----	------	------	-----	-----

Negative Response Packet

STX	Len_H	Len_L	'N'	ST1	ST2	ETX	BCC
-----	-------	-------	-----	-----	-----	-----	-----

Response DATA Structure

Error Count	PSC1(1 Byte , Hex)	PSC2(1 Byte , Hex)
-------------	--------------------	--------------------

D) **'Z14': Read Memory.**

This command is to read main memory.

***As the unit buffer size is 256byte, the unit can read Maximum 256 byte memory data At a Time.**

Command Packet

STX	Len_H	Len_L	'Z'	DATA	ETX	BCC
-----	-------	-------	-----	------	-----	-----

Command DATA Structure

Command[0x31]	Command[0x34]	Start Addr[2 BYTE]	End Addr[2 BYTE]
---------------	---------------	--------------------	------------------

Positive Response Packet

STX	Len_H	Len_L	'P'	STAT	DATA	ETX	BCC
-----	-------	-------	-----	------	------	-----	-----

Negative Response Packet

STX	Len_H	Len_L	'N'	ST1	ST2	ETX	BCC
-----	-------	-------	-----	-----	-----	-----	-----

Response DATA Structure

((End addr – Start addr + 1)Byte , Hex)

Doc No	KYT74XX SERIES SPECIFICATIONS	REV	PAGE	DATE
		J	44 OF 45	2014. 03 .07.

E) **'Z15': Read The Protection Bit.**

This command is to read Protection memory data.

Command Packet

STX	Len_H	Len_L	'Z'	DATA	ETX	BCC
-----	-------	-------	-----	------	-----	-----

Command DATA Structure

Command[0x31]	Command[0x33]
---------------	---------------

Positive Response Packet

STX	Len_H	Len_L	'P'	STAT	DATA	ETX	BCC
-----	-------	-------	-----	------	------	-----	-----

Negative Response Packet

STX	Len_H	Len_L	'N'	ST1	ST2	ETX	BCC
-----	-------	-------	-----	-----	-----	-----	-----

Response DATA Structure

Protection Bit(128Byte, Hex)

F) **'Z16': Full write same character to the Memory without protect.**

This command is to write memory data **from 0x0020 to 0x03FC.**

Command Packet

STX	Len_H	Len_L	'Z'	DATA	ETX	BCC
-----	-------	-------	-----	------	-----	-----

Command DATA Structure

Command[0x31]	Command[0x36]	Write Data [1BYTE]
---------------	---------------	--------------------

Positive Response Packet

STX	Len_H	Len_L	'P'	STAT	DATA	ETX	BCC
-----	-------	-------	-----	------	------	-----	-----

Negative Response Packet

STX	Len_H	Len_L	'N'	ST1	ST2	ETX	BCC
-----	-------	-------	-----	-----	-----	-----	-----

G) **'Z17': Write to the Memory.**

This command is to write memory data.

***As the unit buffer size is 256byte, the unit can write Maximum 256 byte memory data At a Time.**

Command Packet

STX	Len_H	Len_L	'Z'	DATA	ETX	BCC
-----	-------	-------	-----	------	-----	-----

Command DATA Structure

Command[0x31]	Command[0x37]	Start Addr[2 BYTE]	End Addr[2 BYTE]
Write Data			

- Write DATA Length : (End Addr - Start Addr + 1) BYTE

Positive Response Packet

STX	Len_H	Len_L	'P'	STAT	DATA	ETX	BCC
-----	-------	-------	-----	------	------	-----	-----

Negative Response Packet

STX	Len_H	Len_L	'N'	ST1	ST2	ETX	BCC
-----	-------	-------	-----	-----	-----	-----	-----

Doc No	KYT74XX SERIES SPECIFICATIONS	REV	PAGE	DATE
		J	45 OF 45	2014. 03 .07.

H) **'Z18': Write The Protection Bit With data Comparison.**

This command is to write with protection to prevent over-writing.

This command can write on the area where the new data and exist data are same among protected Memories.

***As the unit buffer size is 256byte, the unit can write Maximum 256 byte Protection data At a Time.**

Command Packet

STX	Len_H	Len_L	'Z'	DATA	ETX	BCC
-----	-------	-------	-----	------	-----	-----

Command DATA Structure

Command[0x31]	Command[0x38]	Start Addr[2 BYTE]	End Addr[2 BYTE]
Write Data			

- Write DATA Length : (End Addr - Start Addr + 1) BYTE

Positive Response Packet

STX	Len_H	Len_L	'P'	STAT	DATA	ETX	BCC
-----	-------	-------	-----	------	------	-----	-----

Negative Response Packet

STX	Len_H	Len_L	'N'	ST1	ST2	ETX	BCC
-----	-------	-------	-----	-----	-----	-----	-----

I) **'Z1A': Write Memory Data With Protection Bit.**

This command is to write with protection to prevent over-writing.

This command can write on the area where the new data and exist data are same among protected Memories.

***As the unit buffer size is 256byte, the unit can write Maximum 256 byte Protection data At a Time.**

Command Packet

STX	Len_H	Len_L	'Z'	DATA	ETX	BCC
-----	-------	-------	-----	------	-----	-----

Command DATA Structure

Command[0x31]	Command[0x41]	Start Addr[2 BYTE]	End Addr[2 BYTE]
Write Data			

- Write DATA Length : (End Addr - Start Addr + 1) BYTE

Positive Response Packet

STX	Len_H	Len_L	'P'	STAT	DATA	ETX	BCC
-----	-------	-------	-----	------	------	-----	-----

Negative Response Packet

STX	Len_H	Len_L	'N'	ST1	ST2	ETX	BCC
-----	-------	-------	-----	-----	-----	-----	-----